

# FRC Global

## Copper, Nickel & Lead Refractories

Innovation

High Temp

**FRC**  
Global

# Expert Teams.

# Global Networks.

# Quality Products.

## Who We Are

**FRC Global is a leading supplier of refractories, electrodes, and high temperature combustion systems.**

FRC Global provides outstanding results for our clients within the iron, steel, and non-ferrous industries. Our company's reputation is built by delivering high quality products made with premium raw materials. We are more global now than ever before.

We give you a competitive advantage by offering you superior proven products that positively impact your bottom line and perform better. Our knowledgeable engineers ensure the proper application of our products to give you the maximum level of output and safety.

With over 25 warehouse facilities in the United States, Canada, Mexico, and South America we assure your products are readily available when you need them in these regions.

**Through the use of vast global resources, all of us at FRC Global are committed to being the value creators and problem solvers for our industry.**

# Mission Statement

Embrace modern technology to increase innovation, efficiency, and transparency. Inspire the next generation by driving change, promoting curiosity, and shaping sustainable solutions in the high temp world.



# About Us



## Background information

FRC Global is a second generation family owned company with a 30-year history.

FRC Global has offices, agents, or partners in 20 countries around the world.

Global Offices:

- ◆ North America: United States and Canada
- ◆ South America: Colombia
- ◆ Asia: China

We provide quality engineered products and services for all your high temperature applications.

## FRC Global facts

Our quality control employees thoroughly inspect shipments to ensure products are within specification and are properly packaged.

Sales force and service needs are available in the following:

- ◆ North America
- ◆ Central America
- ◆ South America
- ◆ Europe
- ◆ Middle East

# Why FRC Global?

## Why Us

Our experts in the non-ferrous metals industry provide the products and services that you need to successfully run your plant. We offer brick, specialties, and pre-cast shapes for all types of furnaces and ladles. FRC Global products are based solely on virgin raw materials. No reclaimed brick is used in any of our products. Bricks are produced according to FRC Global's proprietary formula, which has a focus on particle packing and maximum performance.

Our experts and service staff are there for you when you need it. Custom formulations are possible at no additional charge to match the characteristics of your process. We provide stress analysis and evaluations through CAD modelling of the lining. We offer on-site support from industry experts to assist with relines and evaluation of spent linings. Brick products are fired in a computer controlled, state-of-the-art kiln to assure uniformity and consistency. Grinding is available as needed to assure minimum joint gaps to reduce penetration.

Our strong relationships with global enterprises, primarily in strategic raw materials ensure availability, price stability and consistent high quality. We have on-staff engineers, product managers and quality control teams who travel around the world to produce high-end products from only the best raw material to generate superior results for our customers.



# Slag-Cleaning Electric Furnace, SCF (Cu, Ni)

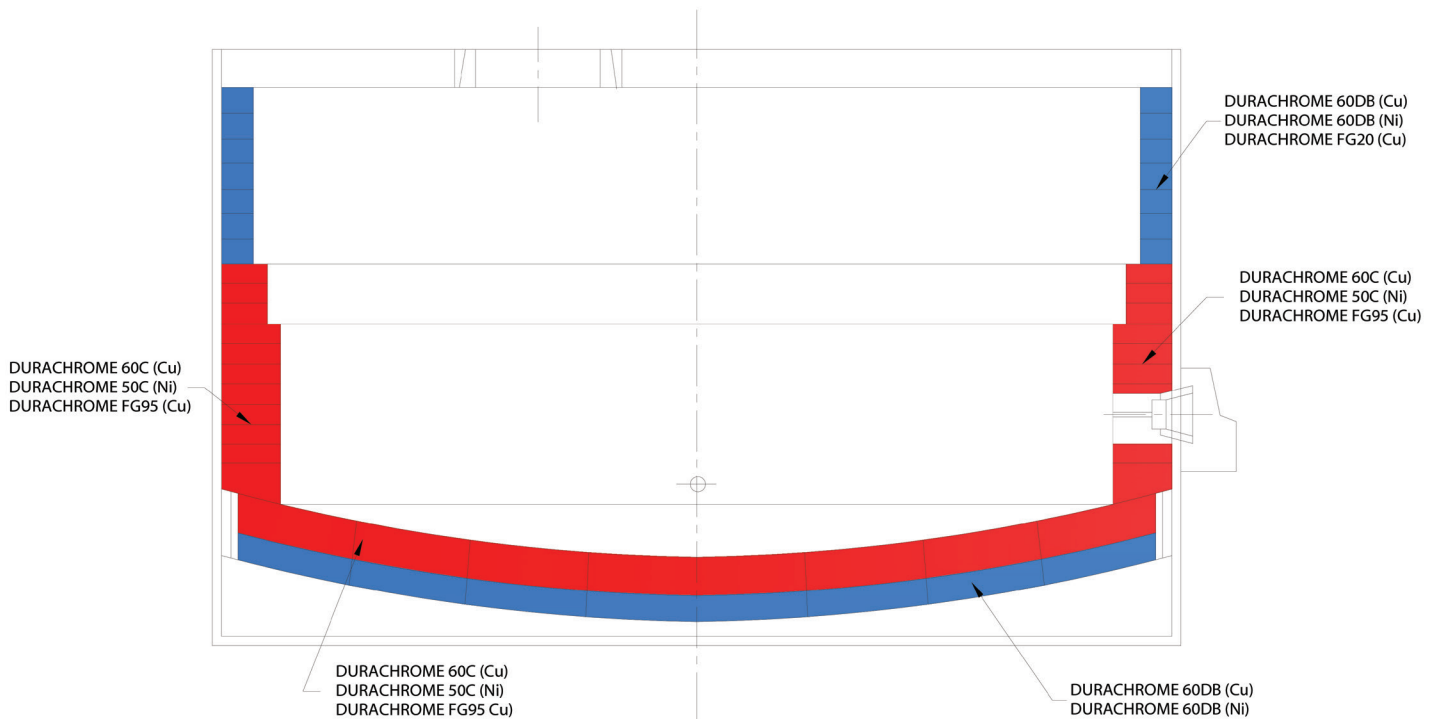

# Converter (Cu, Ni)

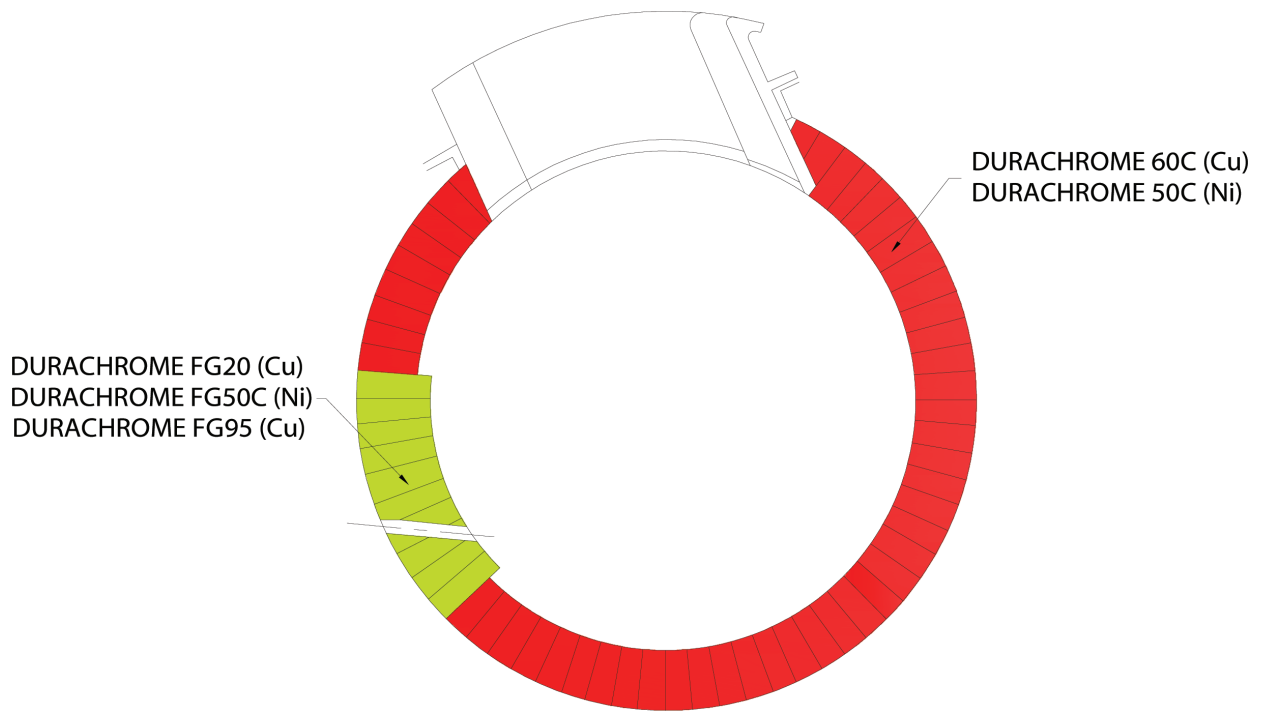
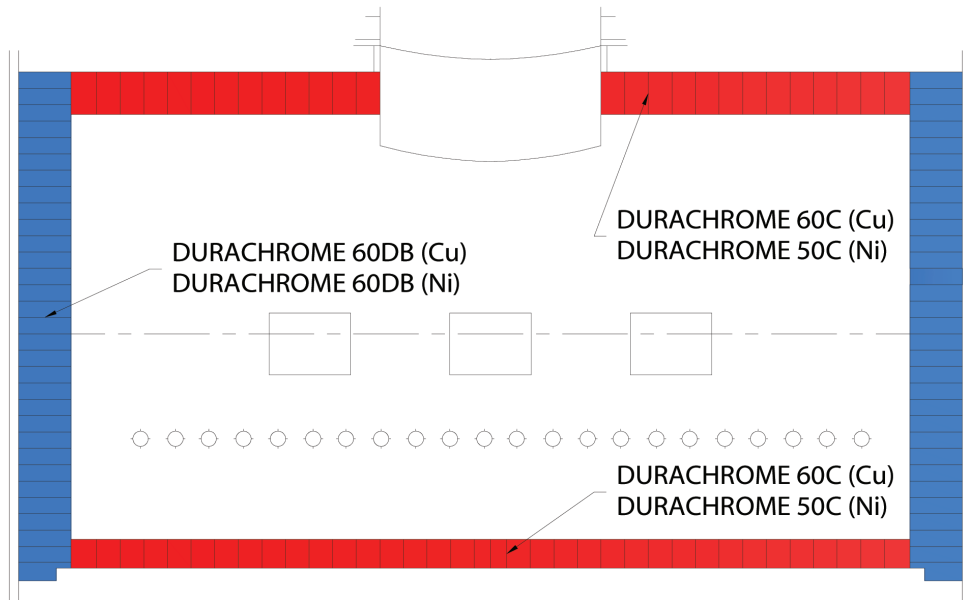

# Drum Type Anode Furnace (Cu, Ni)

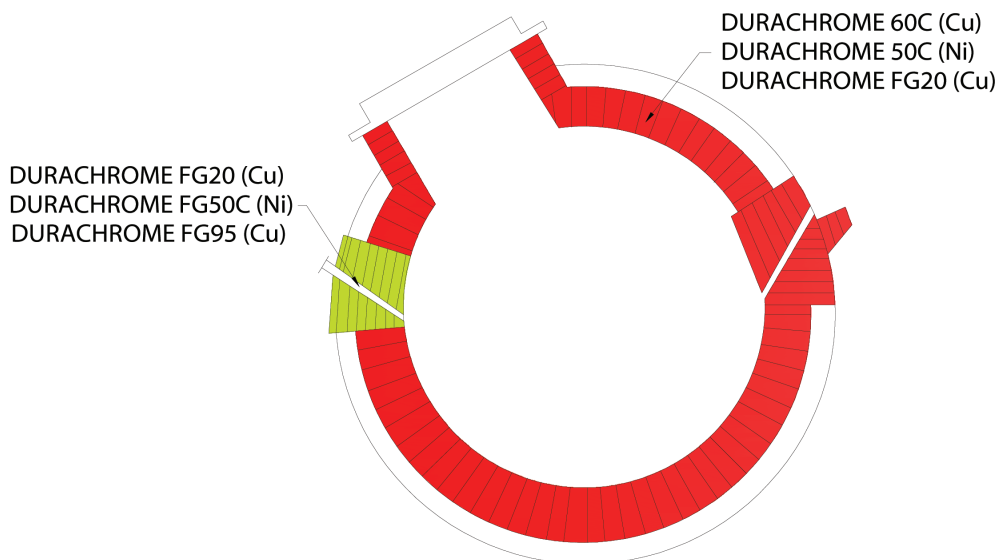
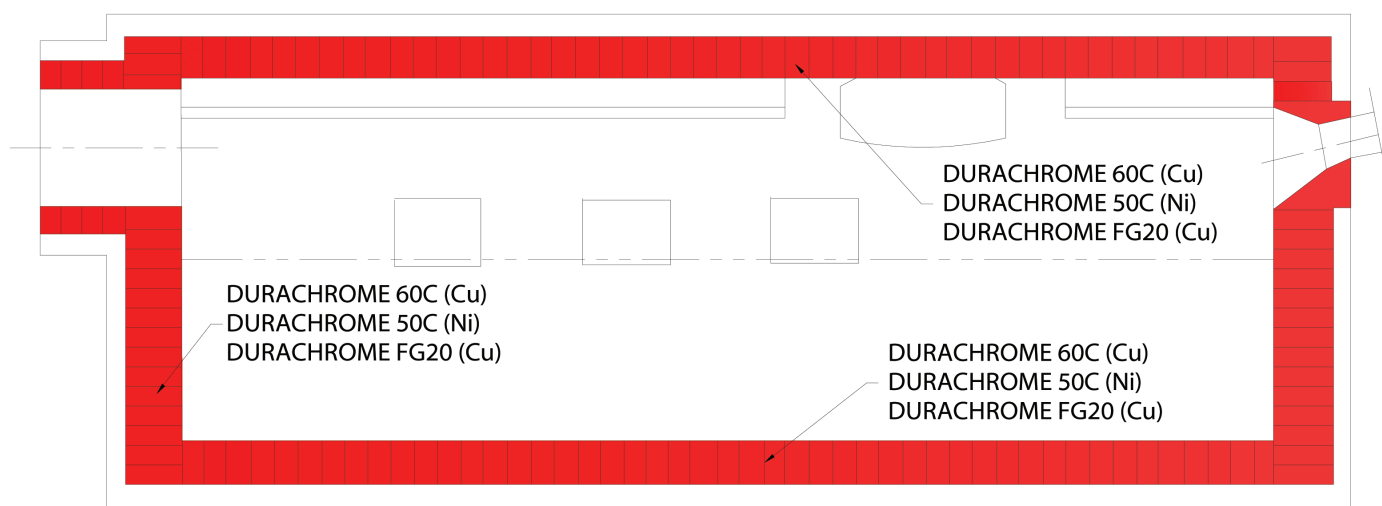



# Flash Smelting Furnace, FSF (Cu, Ni)

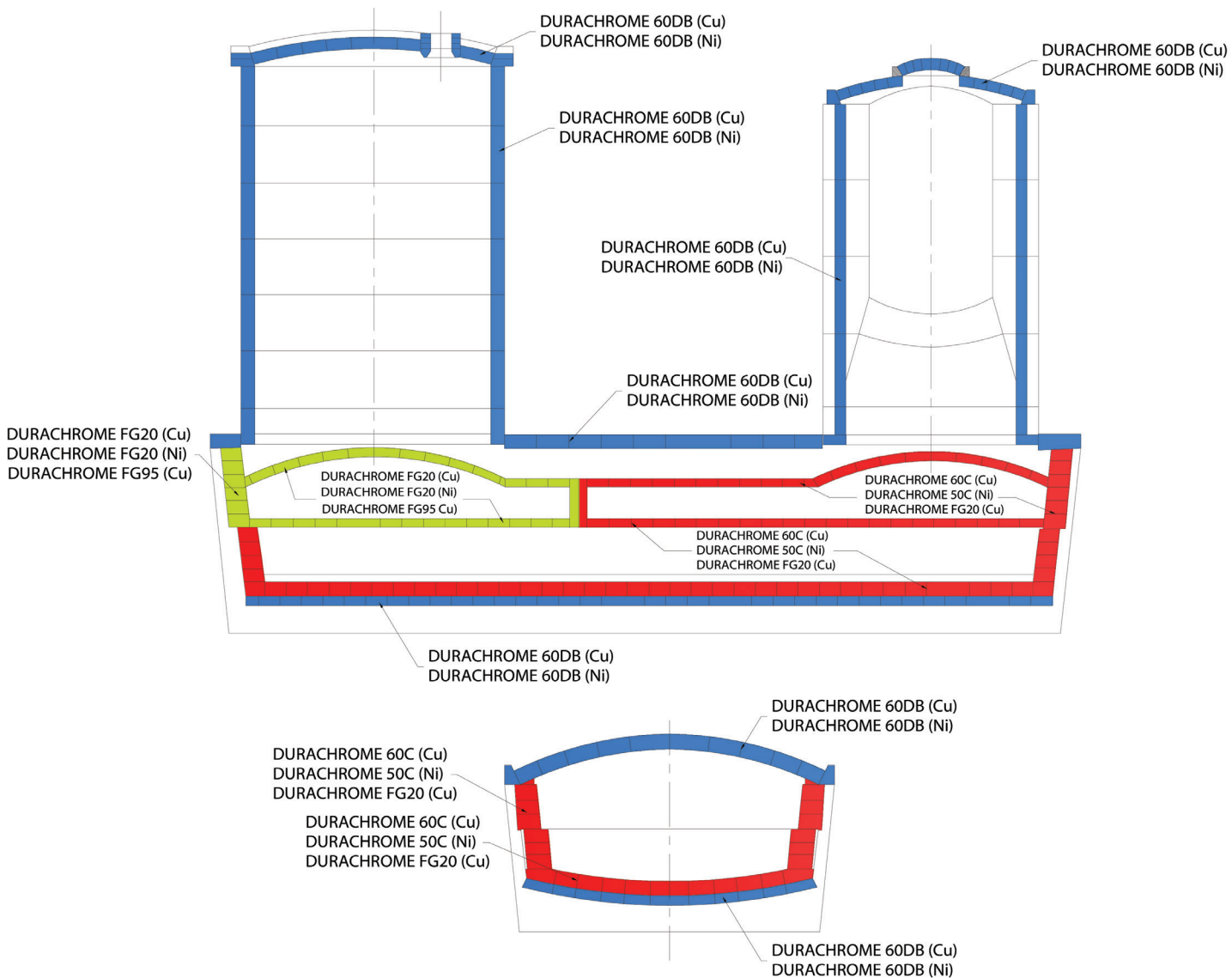

# Ore-Melting Reverberatory Furnace (Cu, Ni)

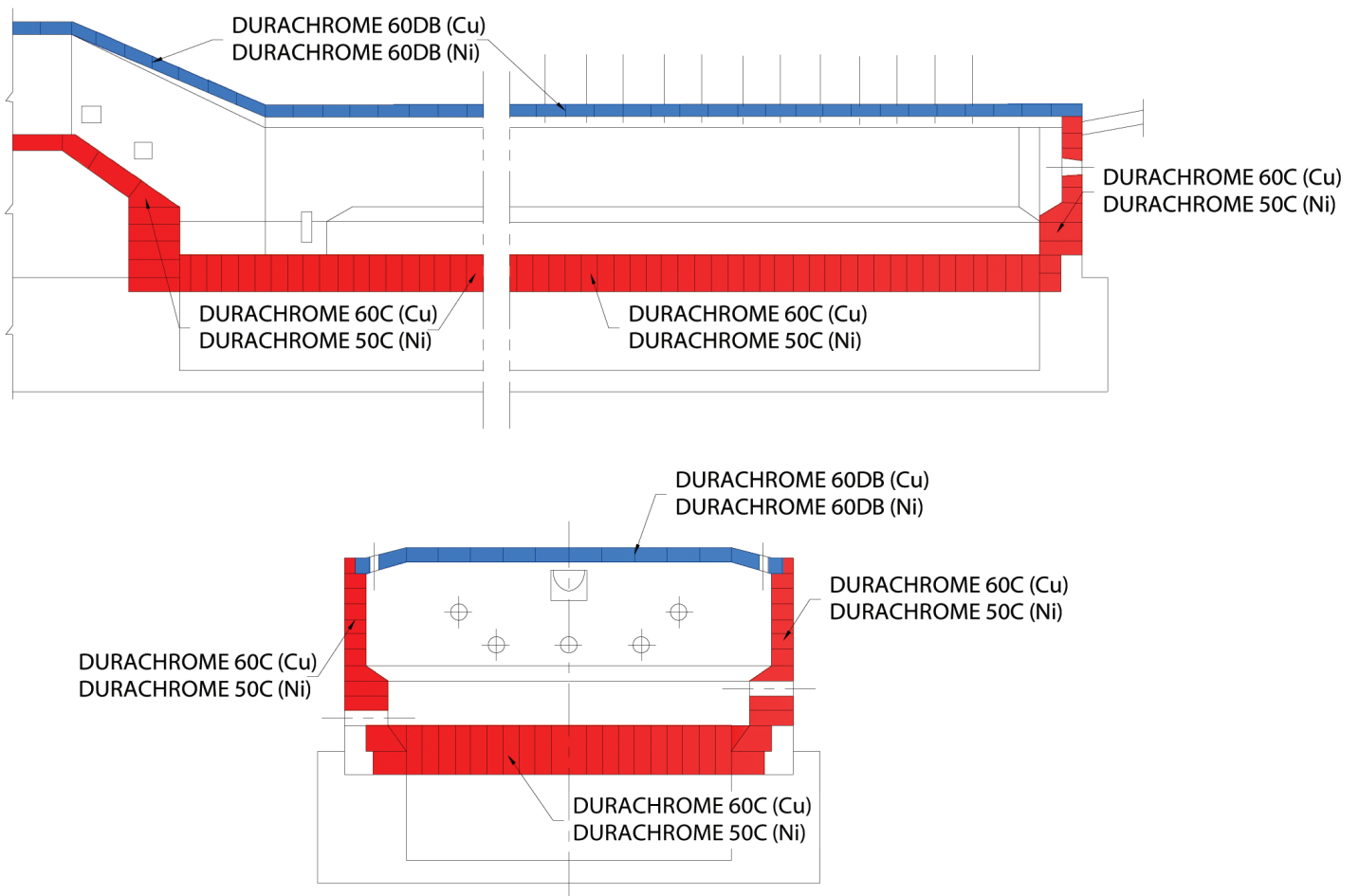

# Ore-Melting Electric Furnace (Cu, Ni)

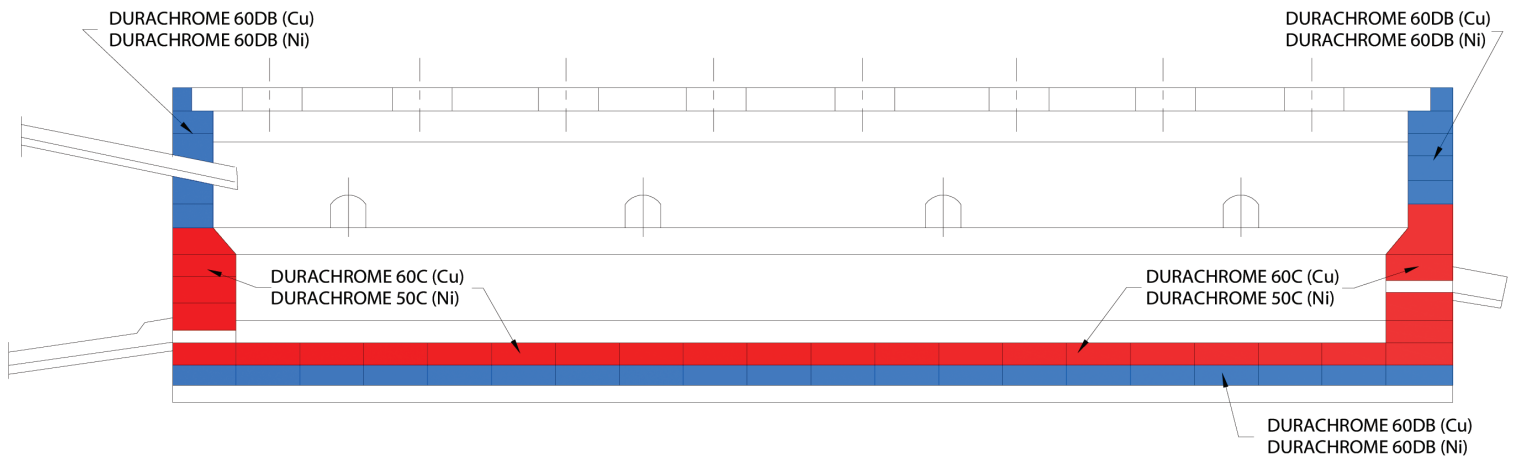

# Electric Arc Furnace for Secondary Refining

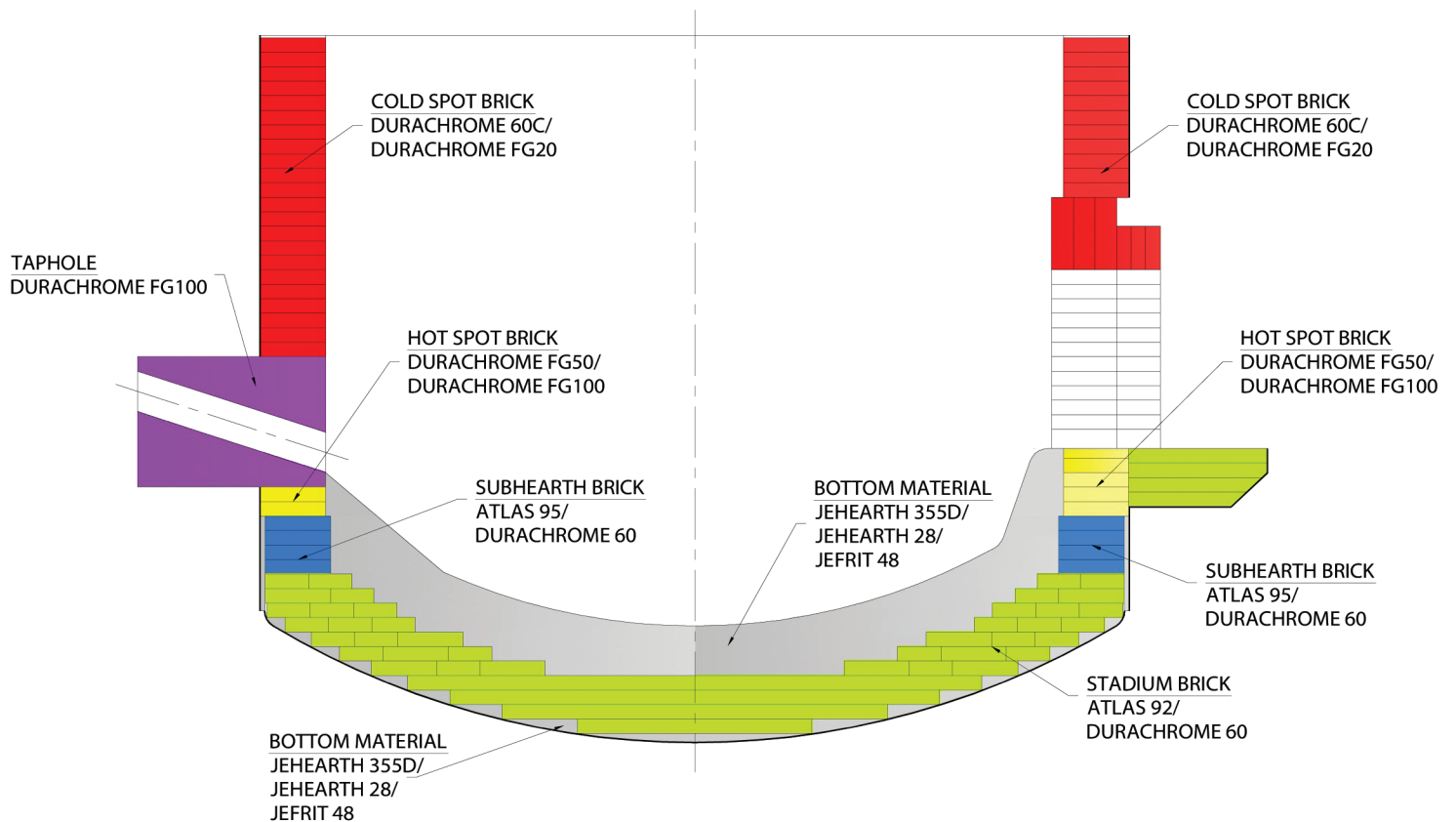

# Converter FRD-33-2302

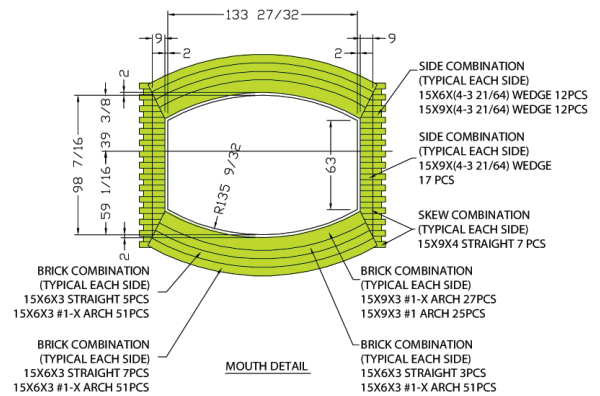
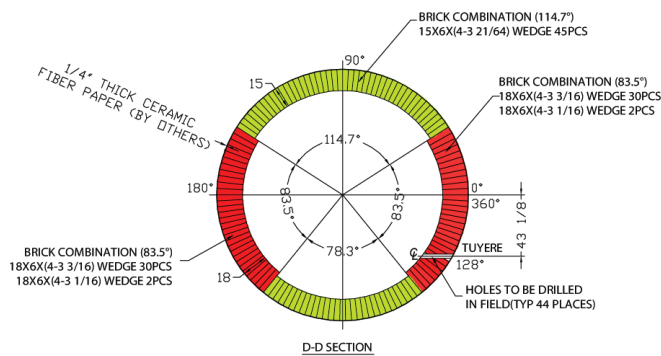
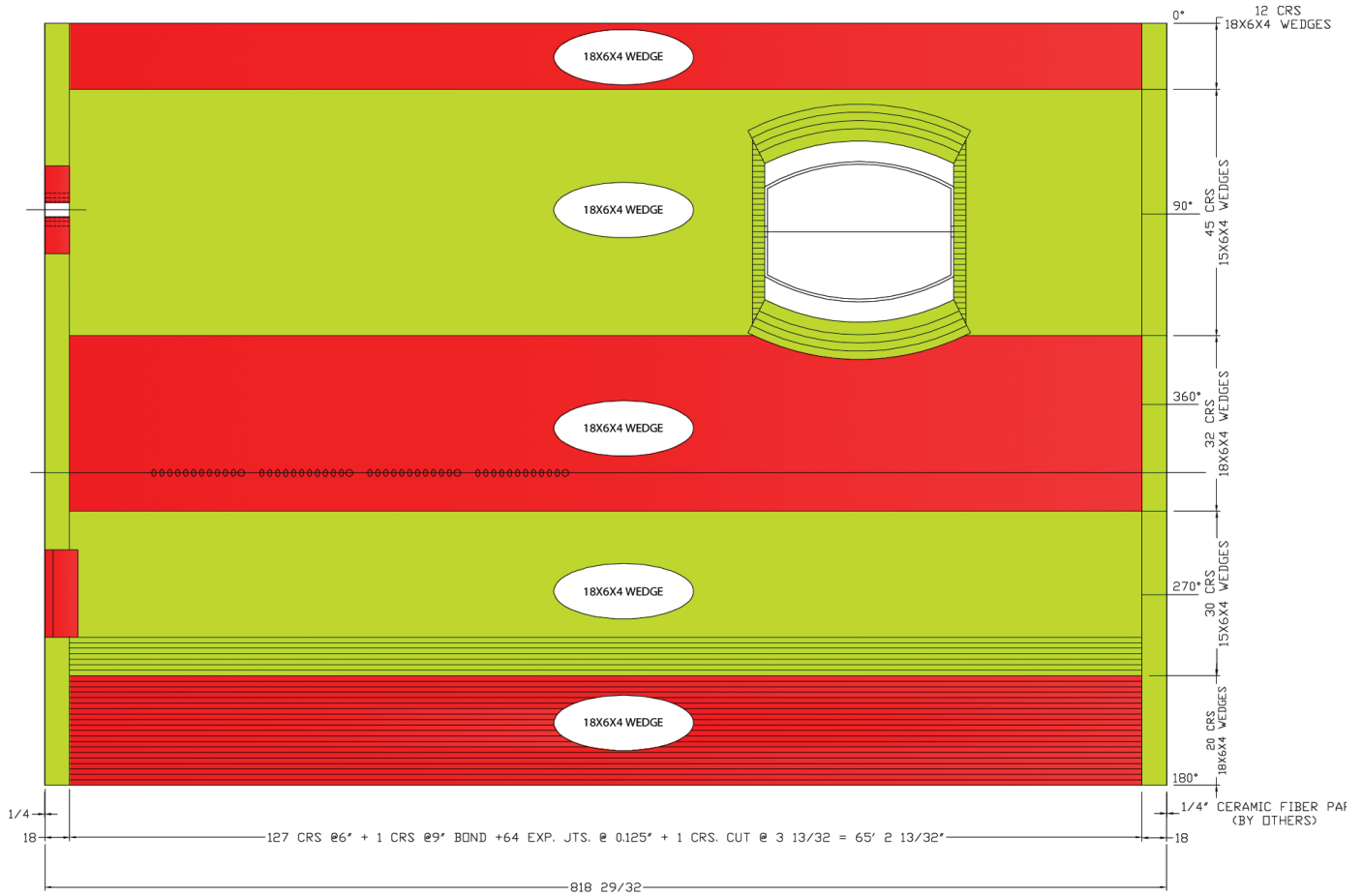

# Installation and Supervision Services



We have the ability to install, supervise, or provide technical assistance with the installation of its refractories as required. Ask your FRC Global representative what is available.

# Working Lining Brick

Product	Chemical analysis % by weight approximate						B. Density (g/cm <sup>3</sup> )	CCS (Mpa)	AP %	Carbon range
	MgO	Cr <sub>2</sub> O <sub>3</sub>	Al <sub>2</sub> O <sub>3</sub>	Fe <sub>2</sub> O <sub>3</sub>	CaO	SiO <sub>2</sub>				
ATLAS 92	>92		1.0	1.0	2.0	<4	2.92	50	<18	---
DURACHROME® 60	>60	17.0	8.2	10.2	2.0	1.5	3.08	45	20.0	---
ATLAS 95	>95.1		0.8	0.8	<1.4	<2	3.00	50	<18	---
DURACHROME® 60	>60	17.0	8.2	10.2	2.0	1.5	3.08	45	20.0	---
DURACHROME® 60C	>60	17.8	10.0	10.2	2.0	1.5	3.1	50	18	
DURACHROME® FG20	>58	18.0	11.0	10.0	2.0	1.5	3.18	60	16	
DURACHROME® FG50	>55	20.0	12.0	10.0	2.0	1.5	3.2	70	15	
DURACHROME® FG100	>55	20.0	12.0	10.0	2.0	1.5	3.3	80	14	
DURACHROME® FG100	>55	20	12.0	10.0	2.0	1.5	3.30	80	14	

Furnace Bottom Material	Chemical analysis % by weight approximate						B. Density Kg/dm <sup>3</sup>	Application	Bond	Grain Size
	MgO	Cr <sub>2</sub> O <sub>3</sub>	Al <sub>2</sub> O <sub>3</sub>	Fe <sub>2</sub> O <sub>3</sub>	CaO	SiO <sub>2</sub>				
JEHEARTH 355D	84.0	---	0.3	4.2	10.0	0.9	2.7	Cold	Ceramic	0-5 mm
JEHEARTH 28	79.7	---	0.5	5.0	14.0	0.8	2.7	Cold	Ceramic	0-8 mm
JEFRIT 48	80.7	---	0.4	6.9	11.1	0.9	2.6	Hot	Ceramic	0-8 mm

Innovation  
High Temp

**FRC**  
Global

# FRC Global

## **United States**

1000 N. West Street, Suite 1200 #3008  
Wilmington, DE 19801

## **Canada**

Montreal, Quebec

## **South America**

Cali, Colombia  
Phone: 011-57-310-826-2701

## **Asia**

Dalian, China

1-800-609-5711

[www.FRCglobal.com](http://www.FRCglobal.com)